

# CMT Series G03

User Manual UM018007E\_20200107



## Table of Contents

|                                                 |    |
|-------------------------------------------------|----|
| Chapter1. Overview .....                        | 1  |
| 1.1. Specification .....                        | 1  |
| 1.2. Dimensions.....                            | 2  |
| 1.3. Connector pin designations .....           | 3  |
| 1.4. Restoring factory default .....            | 3  |
| 1.5. LED indicator .....                        | 3  |
| 1.6. Battery.....                               | 4  |
| 1.7. Power connection .....                     | 4  |
| Chapter2. cMT-G03 System Setting.....           | 5  |
| 2.1. Search for cMT-G03's IP address .....      | 5  |
| 2.2. Set in internet browser .....              | 5  |
| 2.3. System Setting.....                        | 6  |
| 2.3.1. Network .....                            | 6  |
| 2.3.2. Date/Time .....                          | 7  |
| 2.3.3. HMI Name.....                            | 7  |
| 2.3.4. History.....                             | 8  |
| 2.3.5. Email .....                              | 8  |
| 2.3.6. Project Management .....                 | 9  |
| 2.3.7. System Password .....                    | 9  |
| 2.3.8. Enhanced Security .....                  | 10 |
| 2.3.9. EasyAccess 2.0 .....                     | 10 |
| 2.3.10. OPA UA .....                            | 11 |
| 2.3.11. Communication .....                     | 11 |
| Chapter3. Updating Web Package and OS .....     | 12 |
| 3.1. Updating Web Package .....                 | 12 |
| 3.2. Updating OS .....                          | 13 |
| Chapter4. How to create a cMT-G03 project ..... | 14 |
| 4.1. Create a new project.....                  | 14 |
| 4.2. Download project to cMT-G03.....           | 16 |
| 4.3. Monitoring OPC UA Client.....              | 17 |
| 4.4. On-line/Off-line Simulation.....           | 17 |
| Chapter5. Functions supported by cMT-G03 .....  | 19 |
| Chapter6. OPC UA Web Management Interface ..... | 20 |
| 6.1. Introduction .....                         | 20 |
| 6.2. Startup / Shut Down .....                  | 21 |
| 6.3. Server Settings .....                      | 21 |
| 6.4. Edit Node.....                             | 23 |

|           |                          |    |
|-----------|--------------------------|----|
| 6.5.      | Certificates .....       | 24 |
| 6.6.      | Discovery.....           | 25 |
| 6.7.      | Advanced.....            | 26 |
| Chapter7. | Tested PLC Drivers ..... | 27 |

## Chapter1. Overview

### 1.1. Specification



### IIoT Gateway with Serial Bridge

#### Features

- IIoT Gateway with serial bridge can upgrade your existing serial-based controller and touch panel without the need for modifying PLC and HMI projects.
- Transparent (pass-through) between COM1 and COM2
- Supports OPC UA and MQTT
- Compact Design and DIN-rail Mountable
- Fan-less Cooling System
- Built-in 256 MB Flash Memory
- Built-in Power Isolator
- Wide input voltage range: 10.5~28VDC

|                      |                       |                                                                |
|----------------------|-----------------------|----------------------------------------------------------------|
| <b>Memory</b>        | Flash                 | 256 MB                                                         |
|                      | RAM                   | 256 MB                                                         |
| <b>Processor</b>     |                       | ARM RISC 528MHz                                                |
| <b>I/O Port</b>      | SD Card Slot          | N/A                                                            |
|                      | USB Host              | N/A                                                            |
|                      | USB Client            | N/A                                                            |
|                      | Ethernet              | 10/100 Base-T x 1                                              |
|                      | COM Port              | COM1: RS-232 2W, RS-485 2W/4W<br>COM2: RS-232 2W, RS-485 2W/4W |
| <b>RTC</b>           |                       | Built-in                                                       |
| <b>Power</b>         | Input Power           | 10.5~28VDC                                                     |
|                      | Power Isolation       | Built-in                                                       |
|                      | Power Consumption     | 300mA@12VDC;150mA@24VDC                                        |
|                      | Voltage Resistance    | 500VAC (1 min.)                                                |
|                      | Isolation Resistance  | Exceed 50MΩ at 500VDC                                          |
|                      | Vibration Endurance   | 10 to 25Hz (X, Y, Z direction 2G 30 minutes)                   |
| <b>Specification</b> | PCB Coating           | Yes                                                            |
|                      | Enclosure             | Plastic                                                        |
|                      | Dimensions WxHxD      | 109 x 81 x 27 mm                                               |
|                      | Weight                | Approx. 0.14 kg                                                |
|                      | Mount                 | 35 mm DIN rail mounting                                        |
| <b>Environment</b>   | Protection Structure  | IP20                                                           |
|                      | Storage Temperature   | -20° ~ 60°C (-4° ~ 140°F)                                      |
|                      | Operating Temperature | 0° ~ 50°C (32° ~ 122°F)                                        |
|                      | Relative Humidity     | 10% ~ 90% (non-condensing)                                     |
| <b>Certificate</b>   | CE                    | CE marked                                                      |
|                      | UL                    |                                                                |
| <b>Software</b>      |                       | EasyBuilder Pro V6.01.02 or later versions                     |

## 1.2. Dimensions

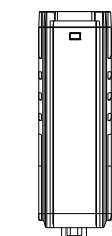
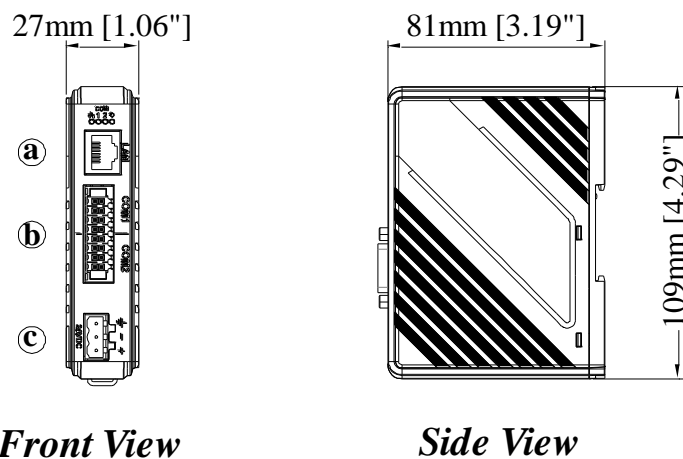

*Top View*

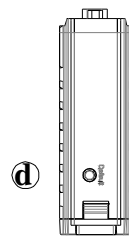

*Bottom View*

|          |                          |
|----------|--------------------------|
| <b>a</b> | Ethernet Port (10M/100M) |
| <b>b</b> | COM1, COM2               |
| <b>c</b> | Power Connector          |
| <b>d</b> | Default Button           |

### 1.3. Connector pin designations

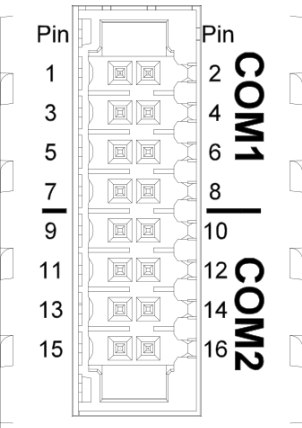

COM1 [RS232-2W;RS-485-2W/4W],  
COM2 [RS232-2W;RS-485-2W/4W]

| PIN# | COM1 [RS232] 2W | COM2 [RS232] 2W | PIN# | COM1 [RS485] |        | COM2 [RS485] |        |
|------|-----------------|-----------------|------|--------------|--------|--------------|--------|
|      |                 |                 |      | 4W           | 2W     | 4W           | 2W     |
| 1    | RXD1            |                 | 2    | Rx1-         | Data1- |              |        |
| 3    | TXD1            |                 | 4    | Rx1+         | Data1  |              |        |
| 5    | FG              |                 | 6    | Tx1-         |        |              |        |
| 7    | GND             |                 | 8    | Tx1+         |        |              |        |
| 9    |                 | RXD2            | 10   |              |        | Rx2-         | Data2- |
| 11   |                 | TXD2            | 12   |              |        | Rx2+         | Data2+ |
| 13   |                 | FG              | 14   |              |        | Tx2-         |        |
| 15   |                 | GND             | 16   |              |        | Tx2+         |        |

### 1.4. Restoring factory default

Press and hold on the Default button on the unit for more than 15 seconds to restore factory default.



LAN: DHCP

Please note that the projects and data stored in the unit are all cleared after pressing the Default button.

### 1.5. LED indicator

LED indicators show the status of IIoT Gateway.



| Icon                                                                                | Color  | Meaning                                                                                                     |
|-------------------------------------------------------------------------------------|--------|-------------------------------------------------------------------------------------------------------------|
|  | Blue   | LAN Communication Status                                                                                    |
|  | Green  | COM1/COM2 Communication Status                                                                              |
|  | Orange | Helps the operator to find the cMT-G03. Triggering system register LB-11959 can turn this indicator on/off. |

## 1.6. Battery

IIoT Gateway requires a CR1220 3V lithium battery to keep the RTC running.

## 1.7. Power connection

**Power:** The unit can be powered by DC power only, the voltage range is compatible with most controller DC systems. The power conditioning circuitry inside the unit is accomplished by a switching power supply. The peak starting current can be as high as 500mA.  
voltage range: 10.5~28 VDC

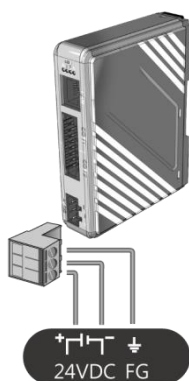

**Note:** Connect positive DC line to the '+' terminal and the DC ground to the '-' terminal.

## Chapter2. cMT-G03 System Setting

Connect cMT-G03 via Ethernet cable, and then configure system settings by the following ways.

### 2.1. Search for cMT-G03's IP address

Launch UtilityManagerEX. On the top-left menu, select cMT Series – Gateway, and then select a function from Reboot, Download, or Upload. cMT-G03 can be found in the IP/HMI Name group box by using the model's IP address, even if the PC or laptop is not on the same network.

UtilityManagerEX can find and change cMT-G03's IP address. The following settings can be carried out after obtaining the IP address.

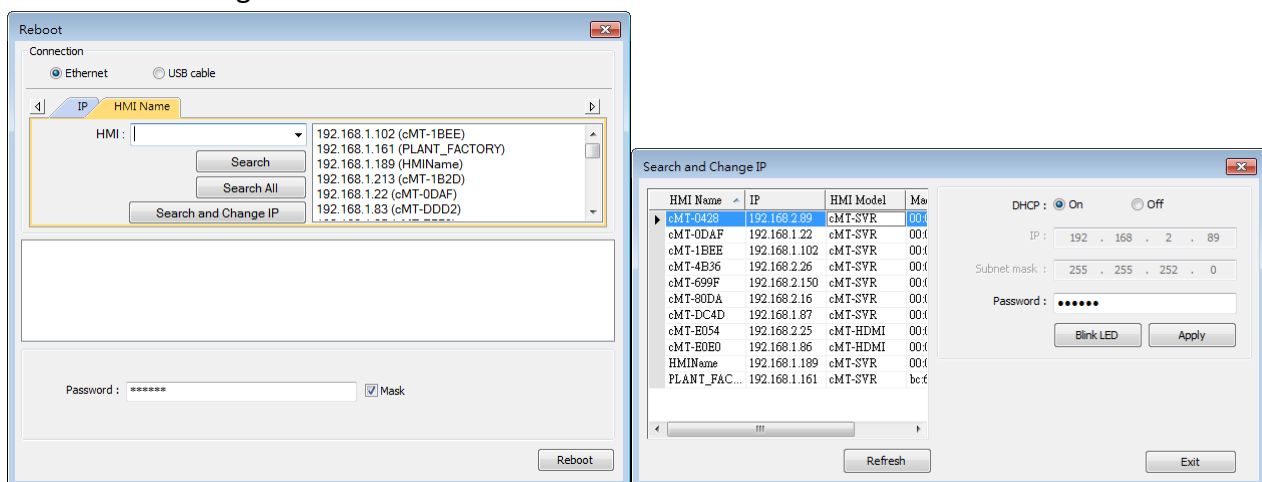

### 2.2. Set in internet browser

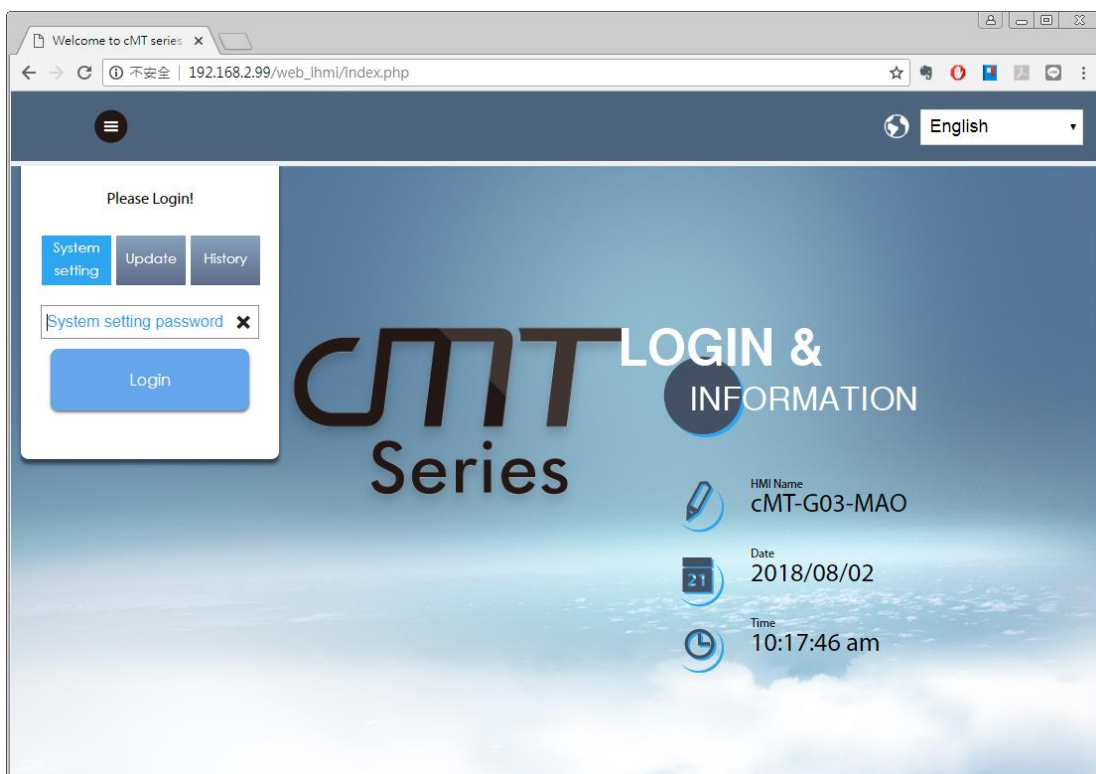

Open internet browser (IE, Chrome, Firefox, Safari), and enter cMT-G03's IP address to configure cMT-G03.





The default IP: LAN: DHCP

cMT-G03 system information is shown in the Login page, and the language used can be changed in this page.

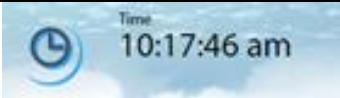
| Icon                                                                              | Description           |
|-----------------------------------------------------------------------------------|-----------------------|
|  | Displays HMI name.    |
|  | Displays system date. |
|  | Displays system time. |

### 2.3. System Setting

The following part introduces cMT-G03 system settings.

Please Login!

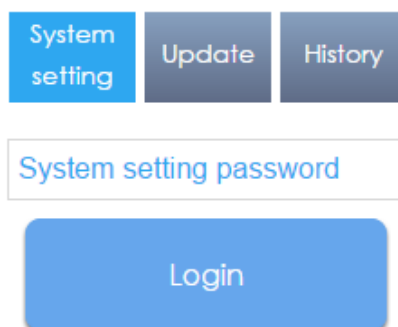

The login interface consists of three buttons at the top: 'System setting' (highlighted in blue), 'Update', and 'History'. Below these buttons is a text input field containing the placeholder text 'System setting password'. At the bottom of the interface is a large blue 'Login' button.

Three levels of privileges can be found:

[System Setting]: Controls all the settings

[Update]: Controls limited items.

[History]: Downloads history data (Recipes and Event Logs).

#### 2.3.1. Network

Configure Ethernet ports: IP, Mask, Gateway, and DNS.

cMT-G03 has one Ethernet port, and is set to DHCP by default.

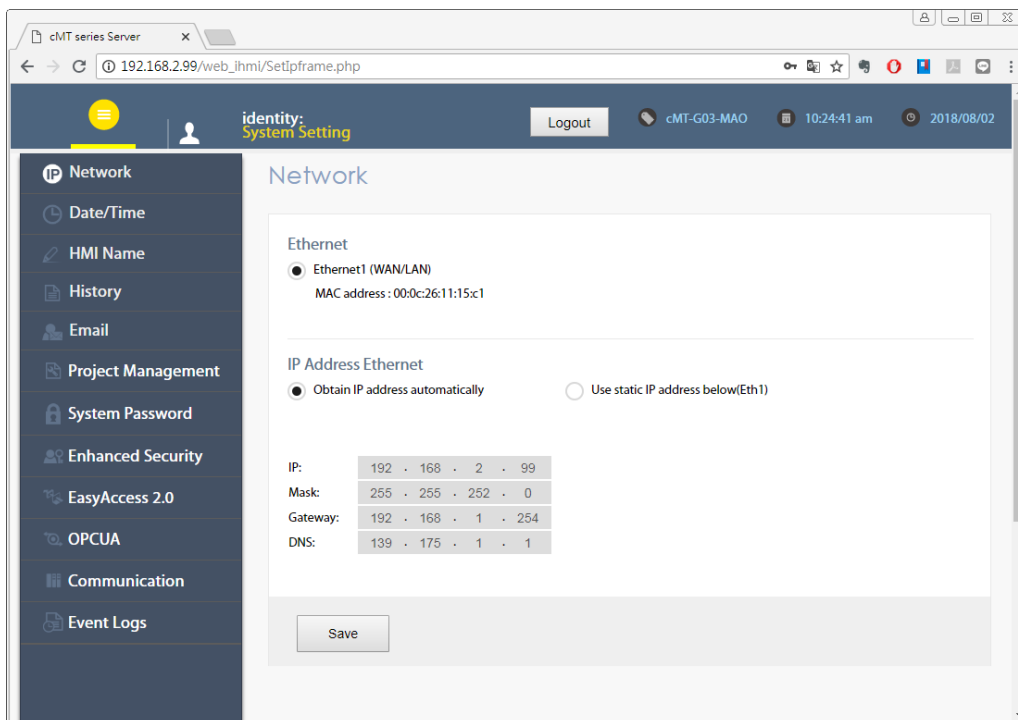

### 2.3.2. Date/Time

Set RTC date and time. Select [Sync. with host] and then click [Save] to synchronize cMT-G03 time with the computer time.

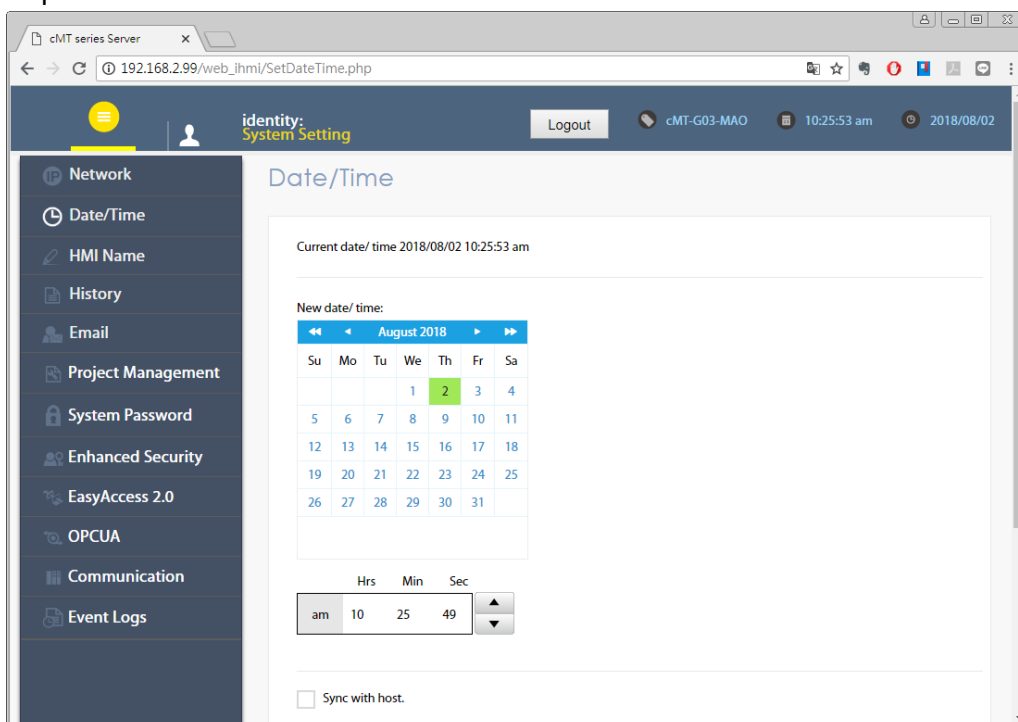

### 2.3.3. HMI Name

Enter a name to identify the unit.

[Identification light]: The LED indicator  of the unit will flash three times when this button is clicked, helping user to find the unit.

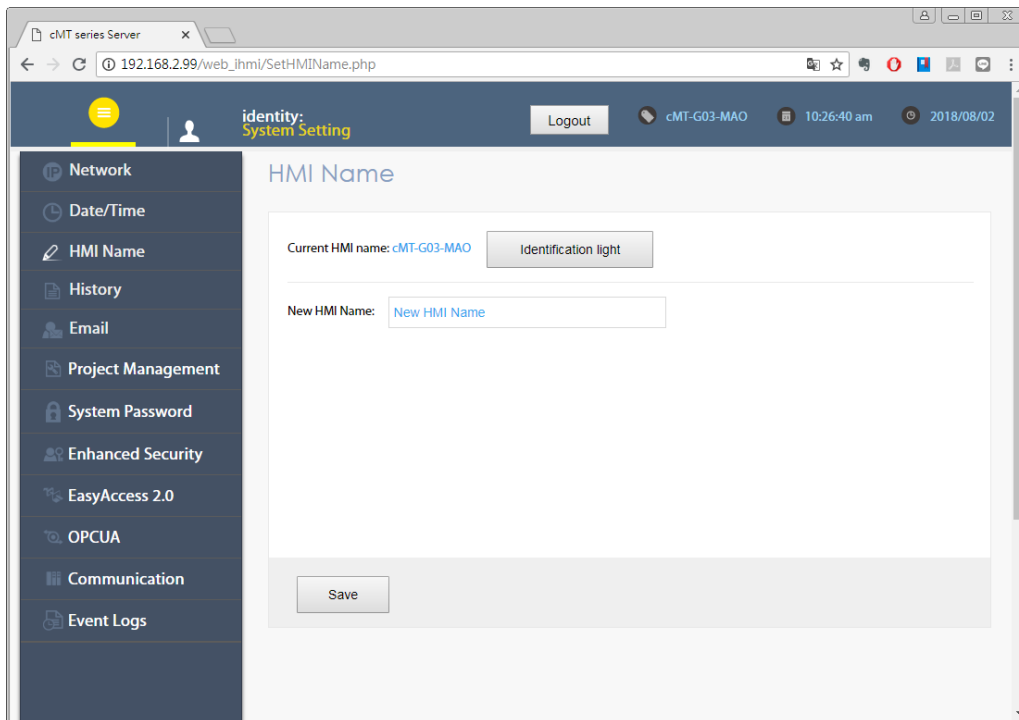

#### 2.3.4. History

This tab offers settings related to historical data.

[Clear]: Clears history data.

[Backup]: Downloads history data in the unit to this computer.

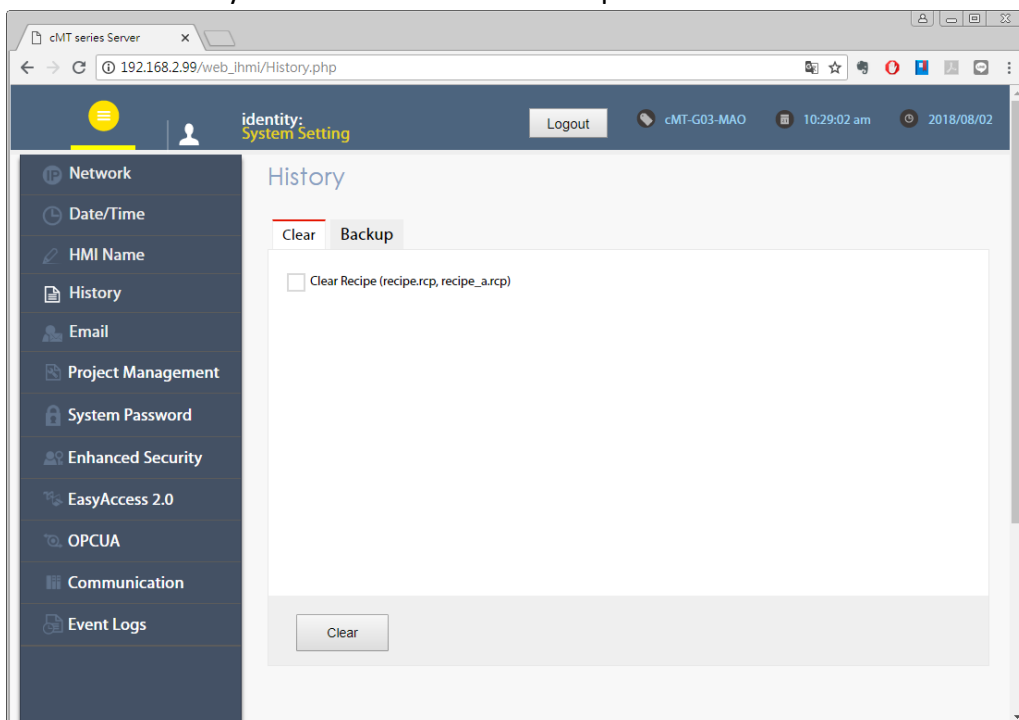

#### 2.3.5. Email

This tab offers settings related to email.

[SMTP]: Configure email server and relevant settings.

[Contacts]: Set email contacts in this tab.

[Update Email Contacts]: Import the email contacts built using Administrator Tools.

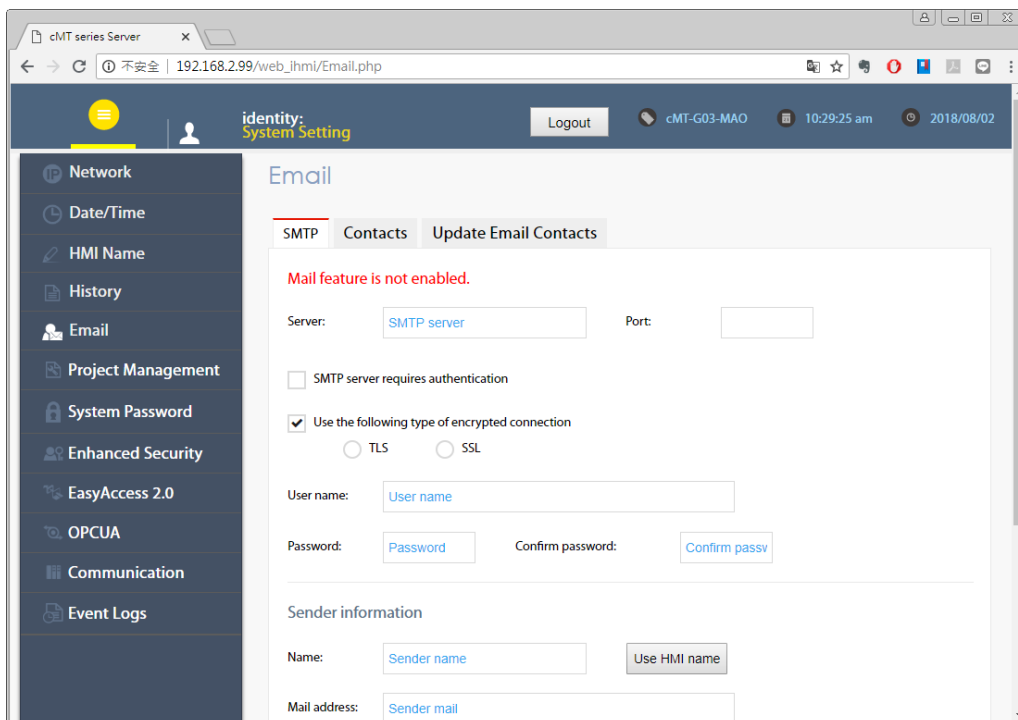

### 2.3.6. Project Management

This tab offers settings related to project management.

[Restart Project]: Restart cMT-G03 project.

[Update Project]: Upload the project's \*.cxob file to cMT-G03.

[Backup Project]: Backup the project file to this computer.

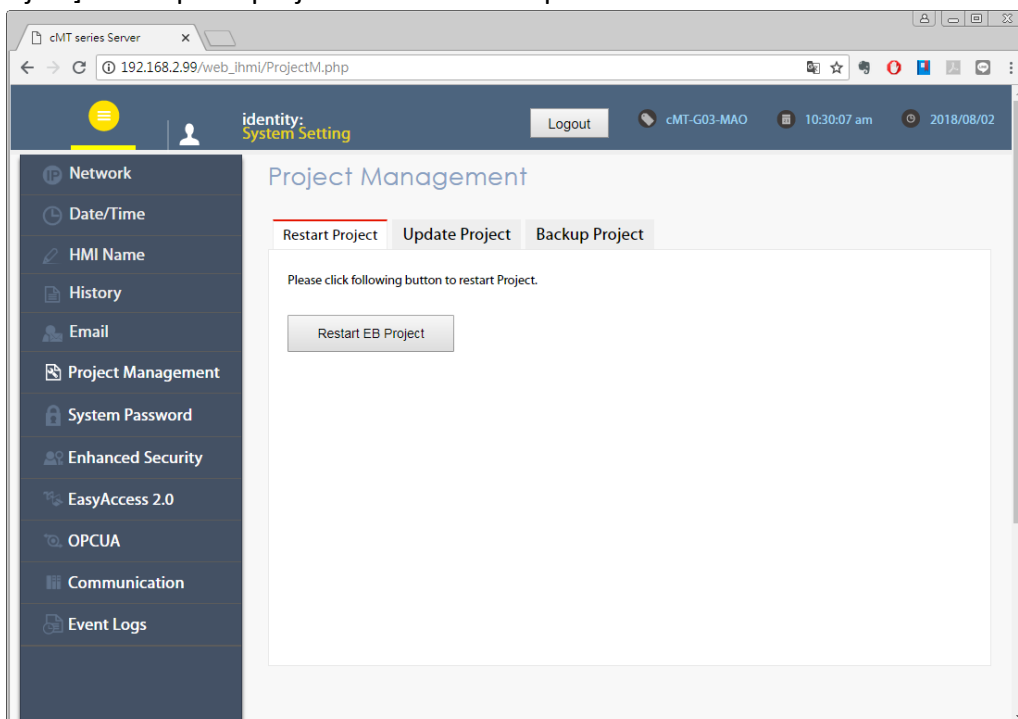

### 2.3.7. System Password

Set login password and the password for transferring project file.

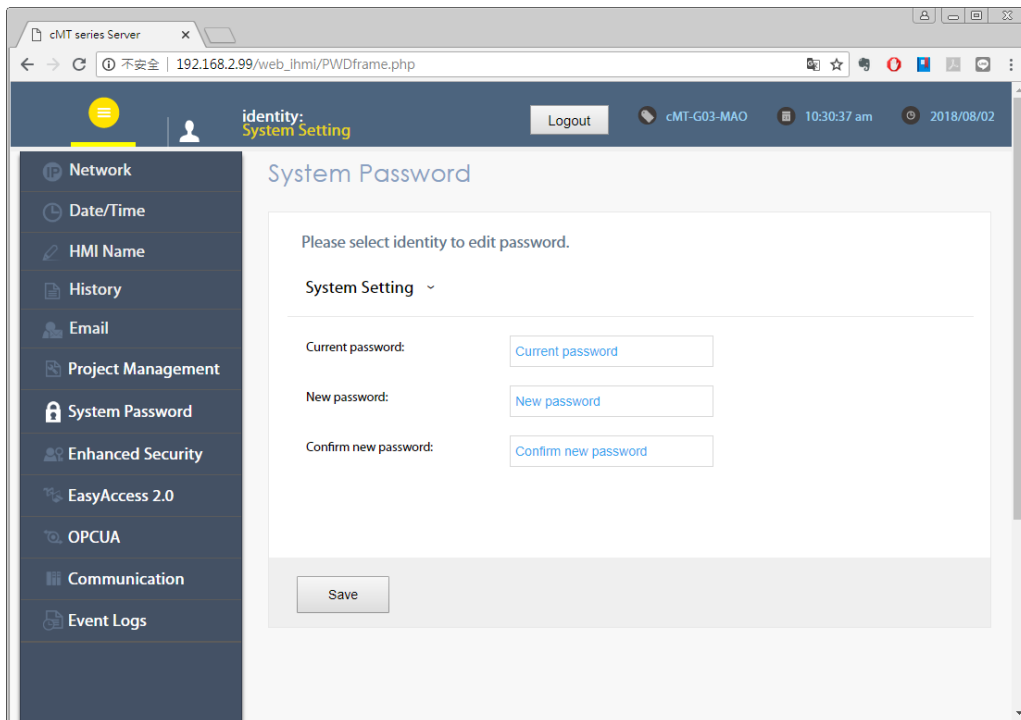

### 2.3.8. Enhanced Security

The account setting in this tab can determine the accounts that can log in OPC UA.

[Accounts]: Add user or change user password and operable classes.

[Import User Account]: Import the user accounts built in Administrator Tools.

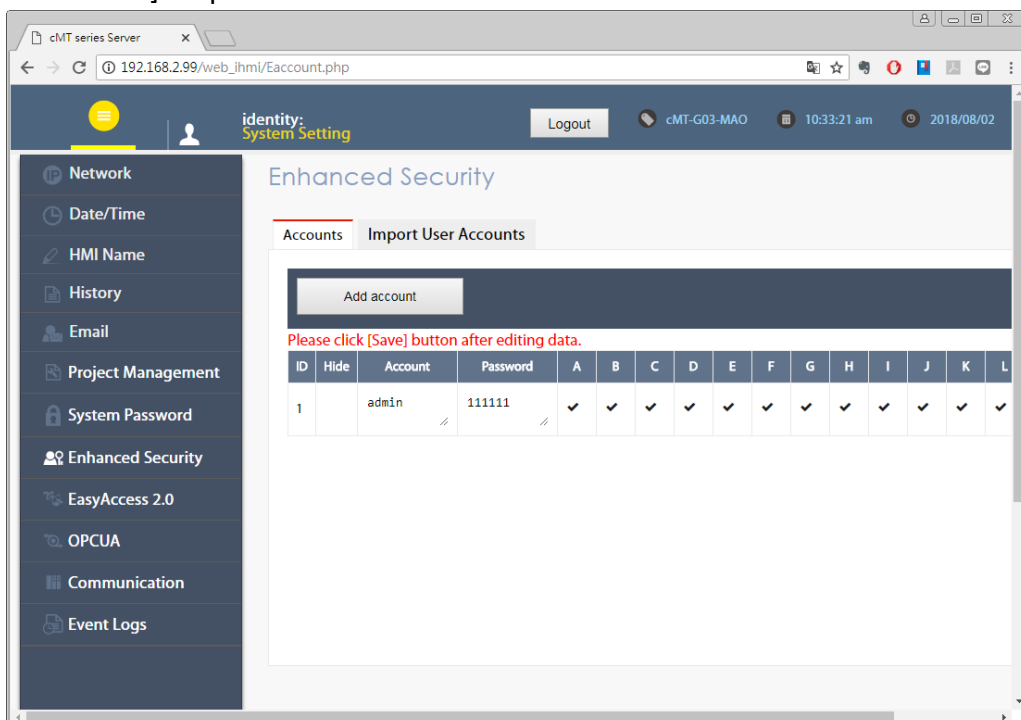

### 2.3.9. EasyAccess 2.0

This tab shows Hardware Key, EasyAccess 2.0 activate status, and proxy settings.

For more information on EasyAccess 2.0, please see EasyAccess 2.0 User Manual.

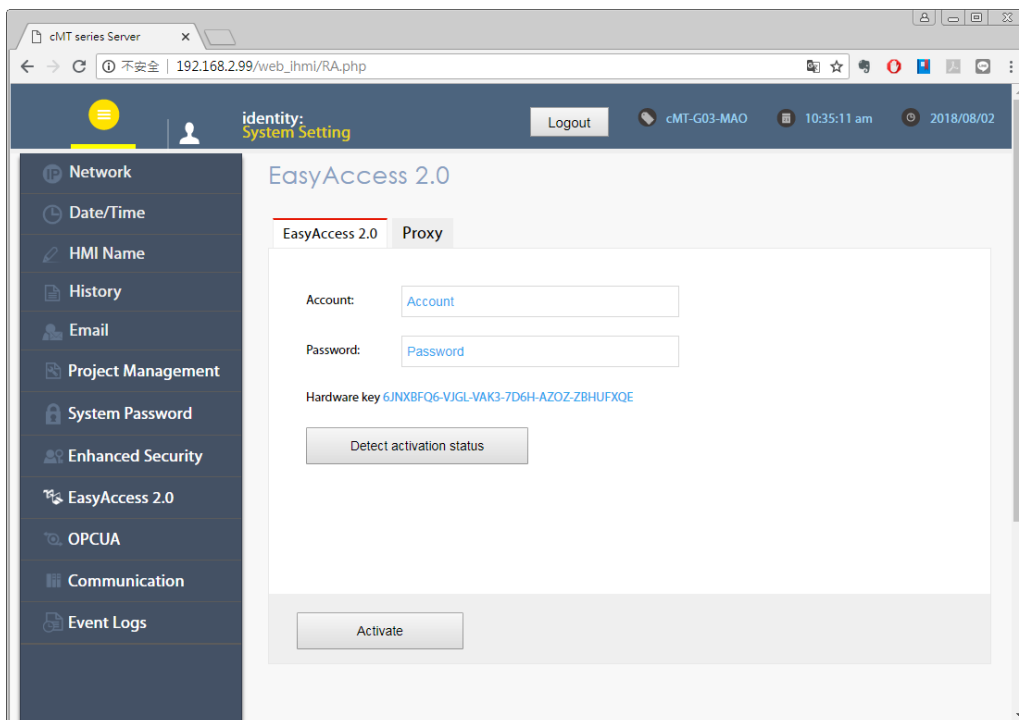

### 2.3.10. OPA UA

Configure OPC UA settings. Please see “Chapter 6 OPC UA Web Management Interface” in this manual for details.

### 2.3.11. Communication

This tab displays the communication parameters of the device connected to cMT-G03.

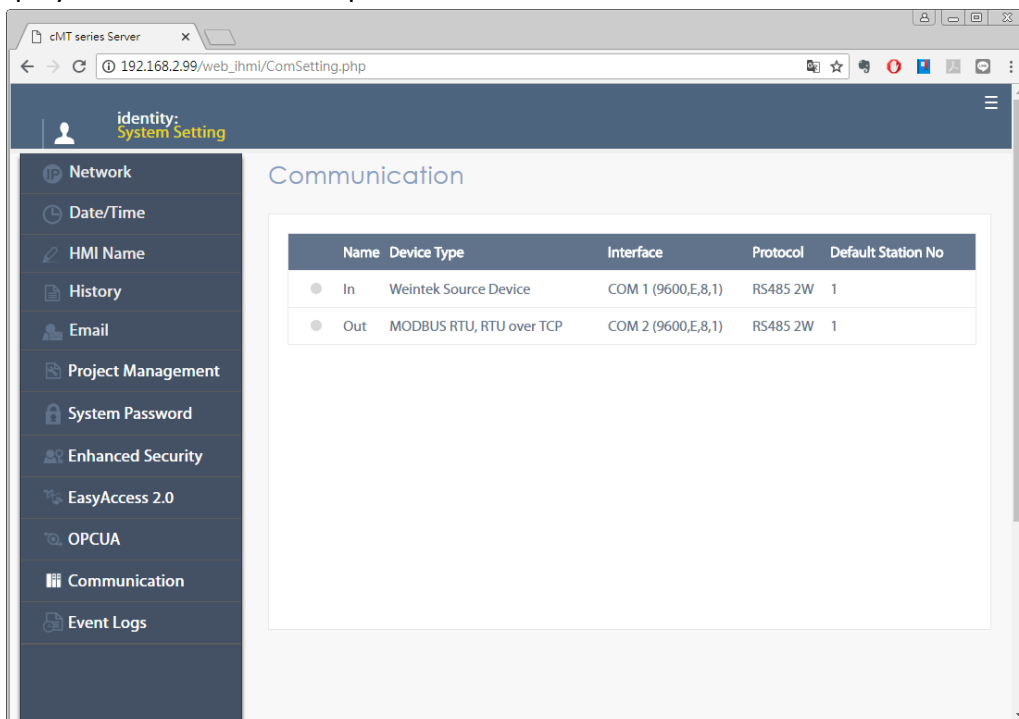

### Chapter3. Updating Web Package and OS

cMT-G03 Web Package and OS can be updated through Ethernet. Launch UtilityManagerEX, select [cMT Series-Gateway] » [Maintenance] » [cMT-Gateway OS Update].

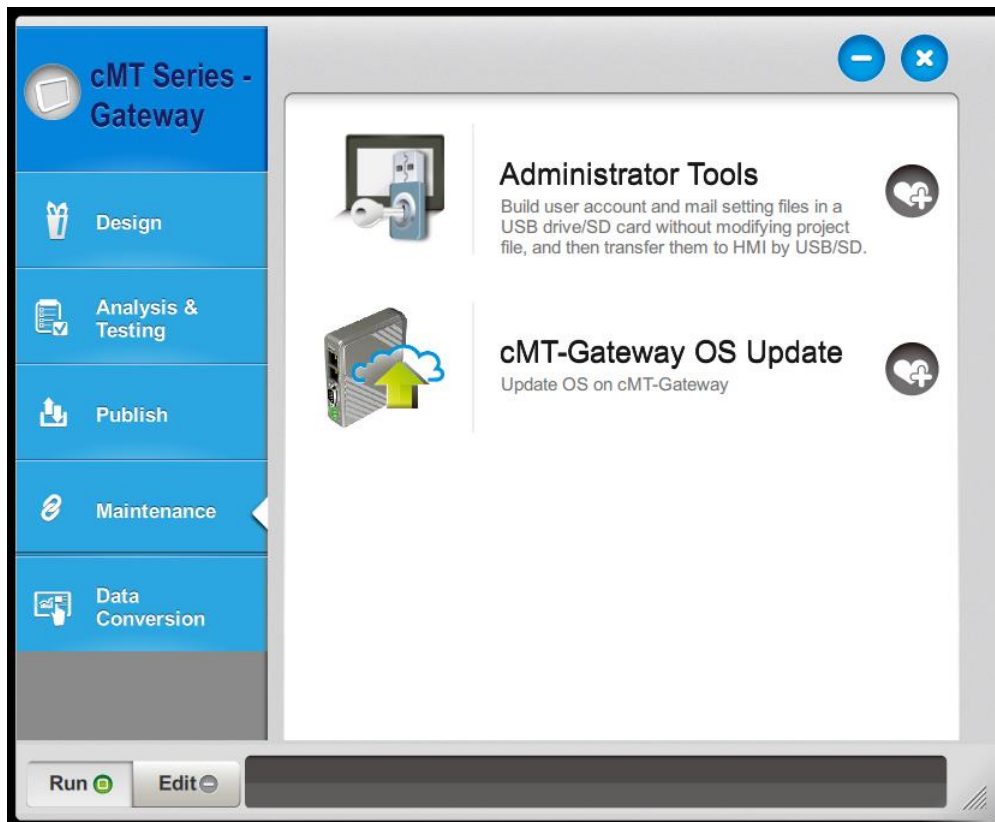

#### 3.1 Updating Web Package

1. Select a cMT-Gateway to update OS.
2. Select [Web package] and browse for the source file.
3. Click [Update].

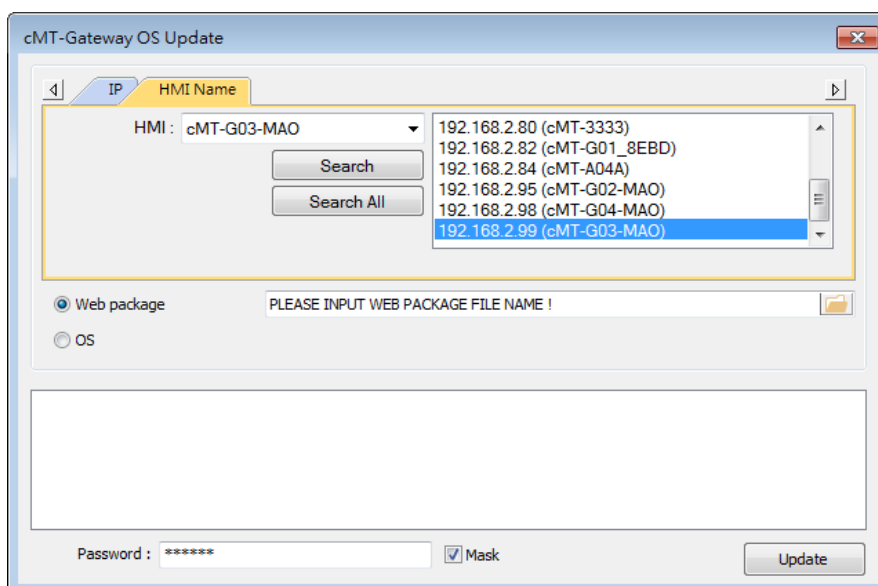

### 3.2 Updating OS

1. Select a cMT-Gateway to update OS.
2. Select [OS], a Warning message shows, please read this message carefully before you click [OK].

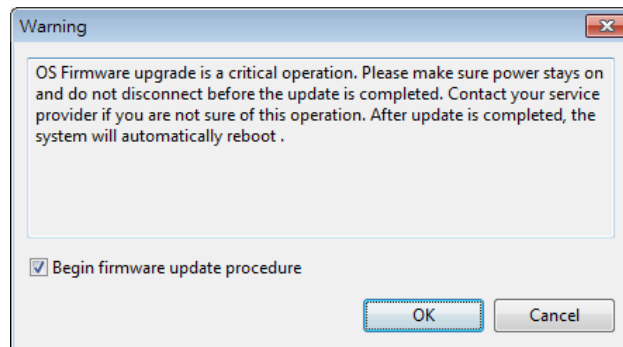

3. If you click [OK], the cMT-Gateway OS Update window opens again, browse for the source file, and then click [Update].

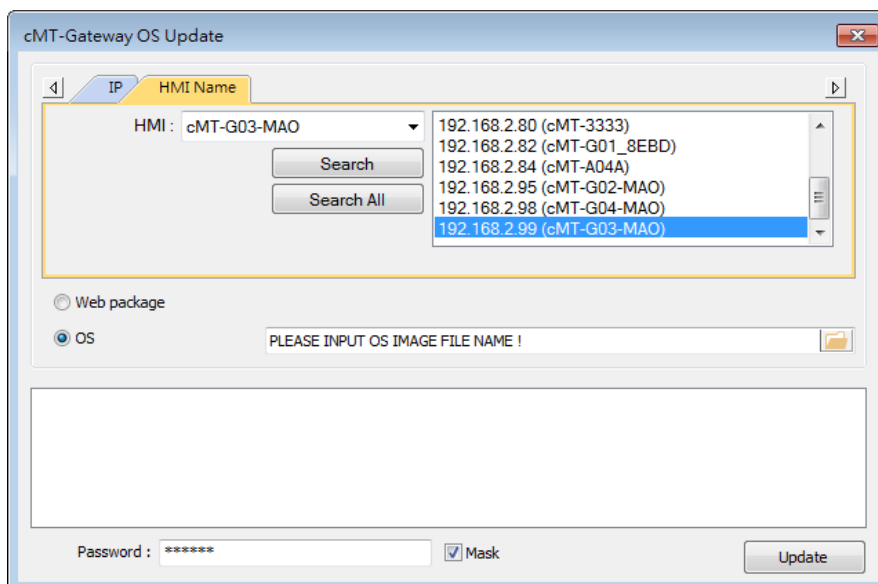

4. The message window below opens, please do not turn off the power while upgrading.

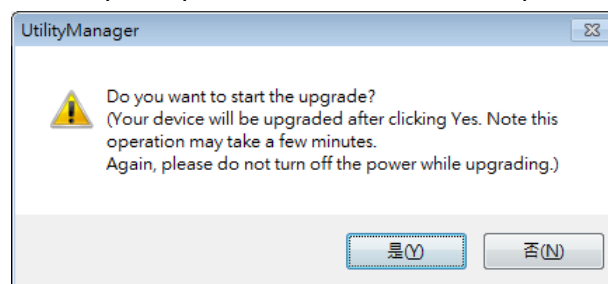

5. When finished, cMT-Gateway OS Update window shows "finished".



## Chapter4. How to create a cMT-G03 project

This chapter explains how to create a project when cMT-G03 is used as an OPC UA Server, and how to set the addresses used to communicate with OPC UA Clients. The basic steps are:

1. Add a driver into Device List in EasyBuilder Pro.
2. Enable OPC UA Server and designate communication address.
3. Download the project to HMI.

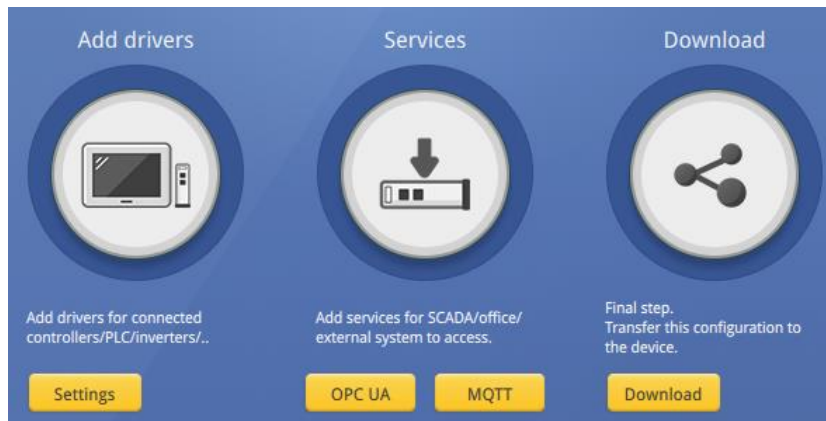

The following explains how to set up OPC UA Server in the project.

### 4.1. Create a new project

Step 1. Launch EasyBuilder Pro and select a cMT-G03.

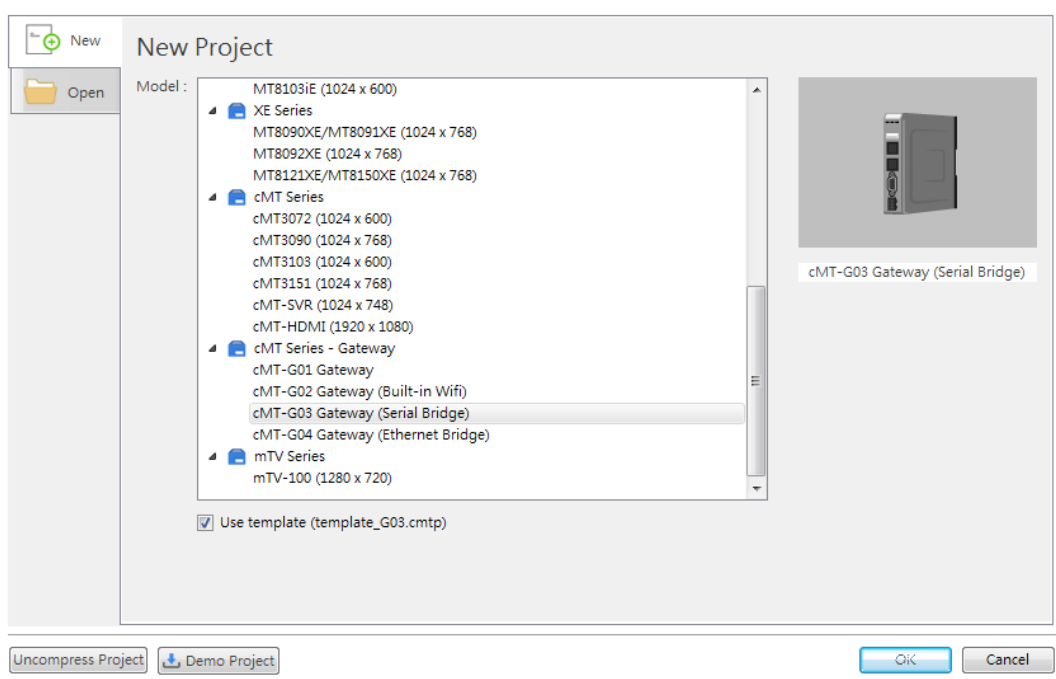

Step 2. Configure In(HMI)/Out(PLC) communication parameters.

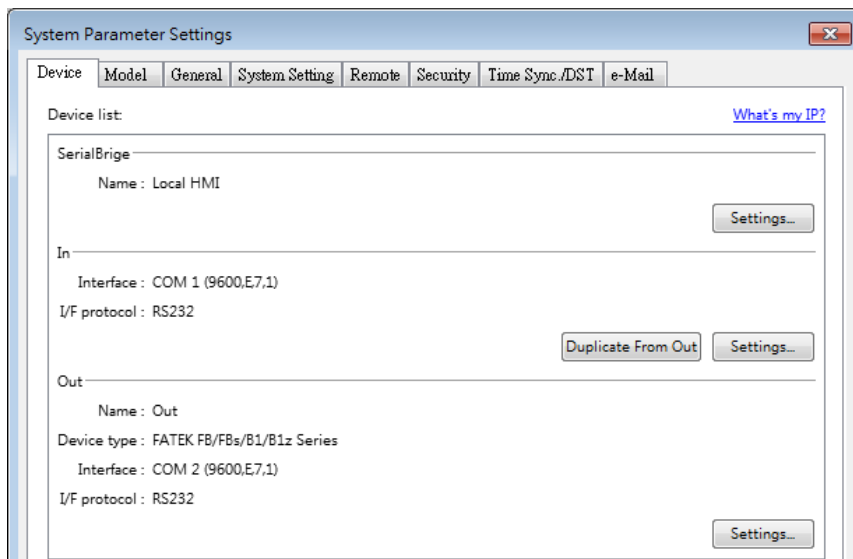

Step 3. Click [IIoT/Energy] » [OPC UA Server], and select [Enable] check box to enable OPC UA Server.

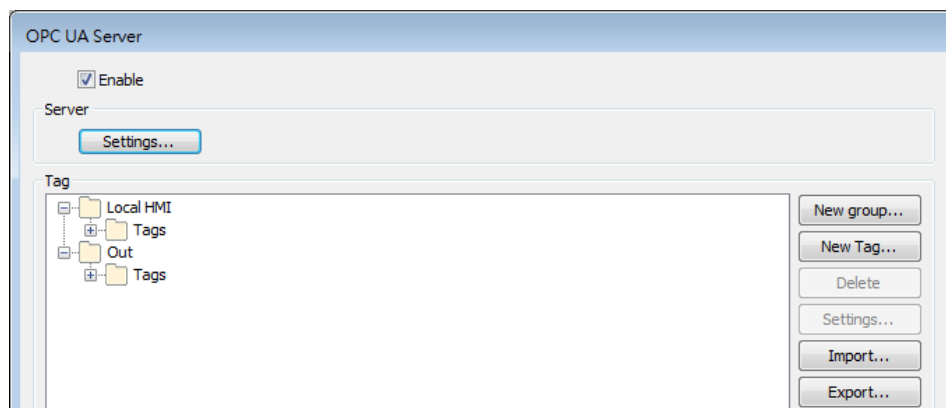

Step 4. Click [Tags] of the device and then click [New Tag] to add tags monitored using OPC UA. When finished, click [OK] to leave.

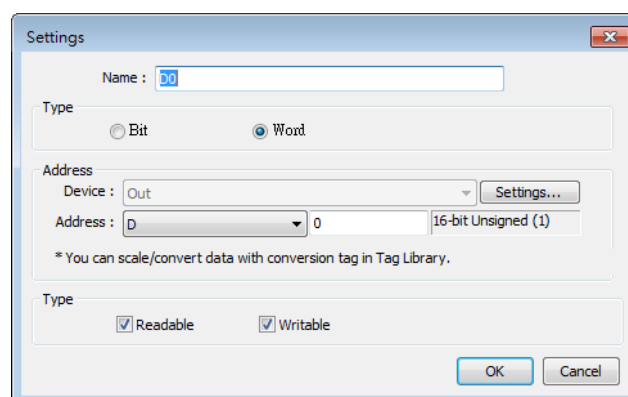

Step 5. Find the created tags in OPC UA Server window.

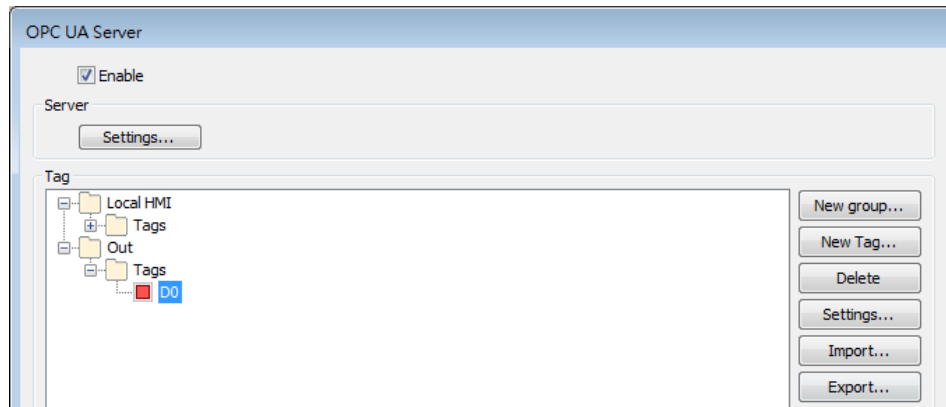

## 4.2. Download project to cMT-G03

The format of the project file run on cMT-G03 is \*.cxob. In EasyBuilder Pro, click [Project] » [Compile] to compile the project into \*.cxob format. When finish compiling, you can download the project to cMT-G03 by two ways.

Way 1: Download using EasyBuilder Pro. Click [Project] » [Download(PC->HMI)], and set HMI IP address. The project can be downloaded via Ethernet.

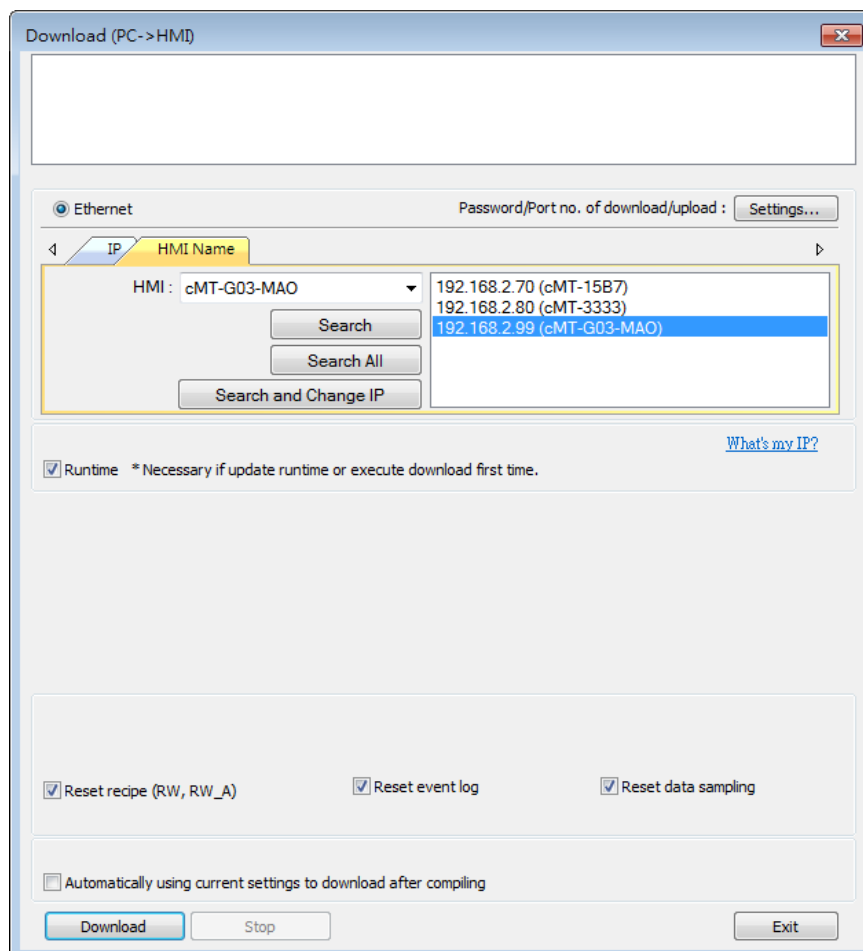

Way 2: Download using website. Open internet browser (IE, Chrome, Firefox, Safari), enter cMT-G03 IP address, click System Setting, enter password, and then configure cMT-G03 settings. Go to [Project Management] page and open [Upload Project] tab to download the project file from the

computer to cMT-G03.

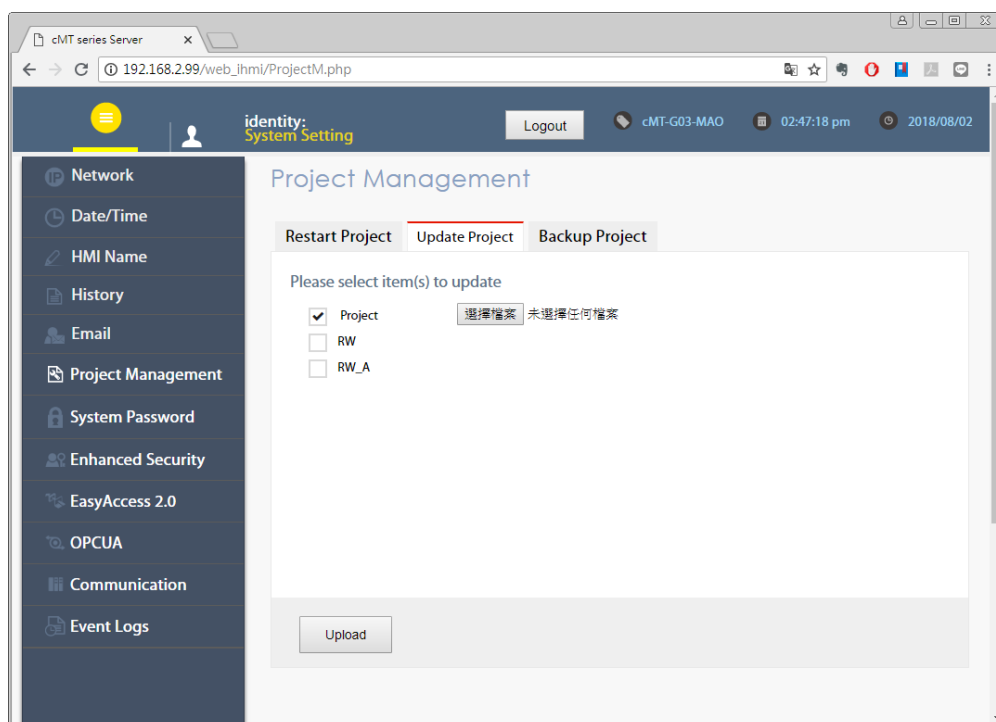

### 4.3. Monitoring OPC UA Client

After downloading the project file, use OPC UA Client software to connect with cMT-G03 to monitor OPC UA Tag data.

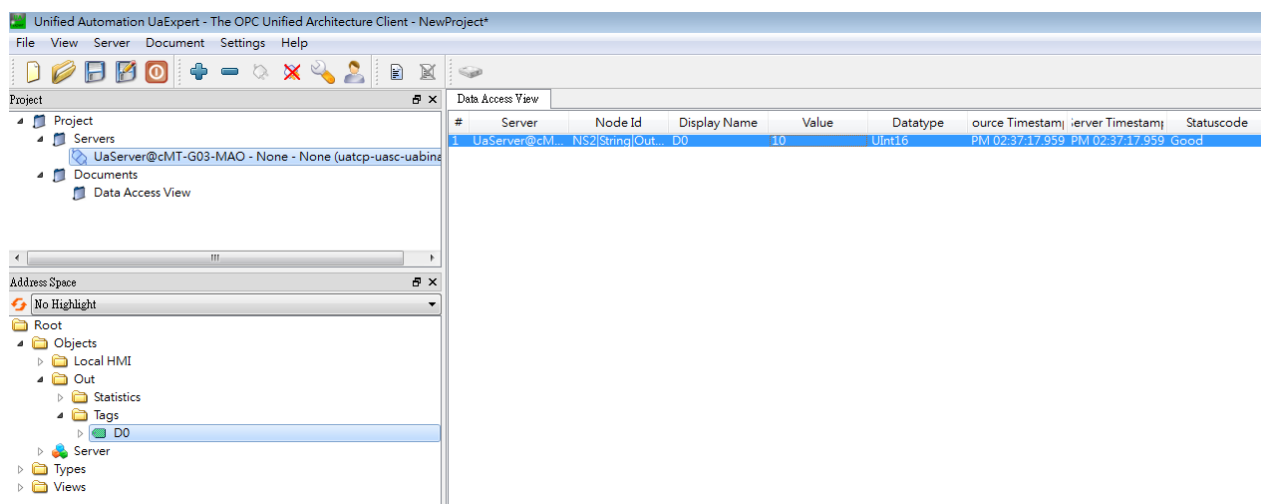

Note: For more information on OPC UA Client software settings, please see OPC UA server manual..

### 4.4. On-line/Off-line Simulation

Running On-line or Off-line simulation in EasyBuilder Pro helps you examine OPC UA Tag settings. In On-line simulation, cMT Gateway Viewer can read from / write to PLC. Please note that On-line simulation is limited to 10 minutes.

Step 1. In EasyBuilder Pro click [Project] » [On-line Simulation] / [Off-line Simulation] to open cMT Gateway Viewer window.

Step 2. Add the tags to be previewed into the Monitor list on the right side.

Step 3. In On-line Simulation, data in PLC tags will also change.

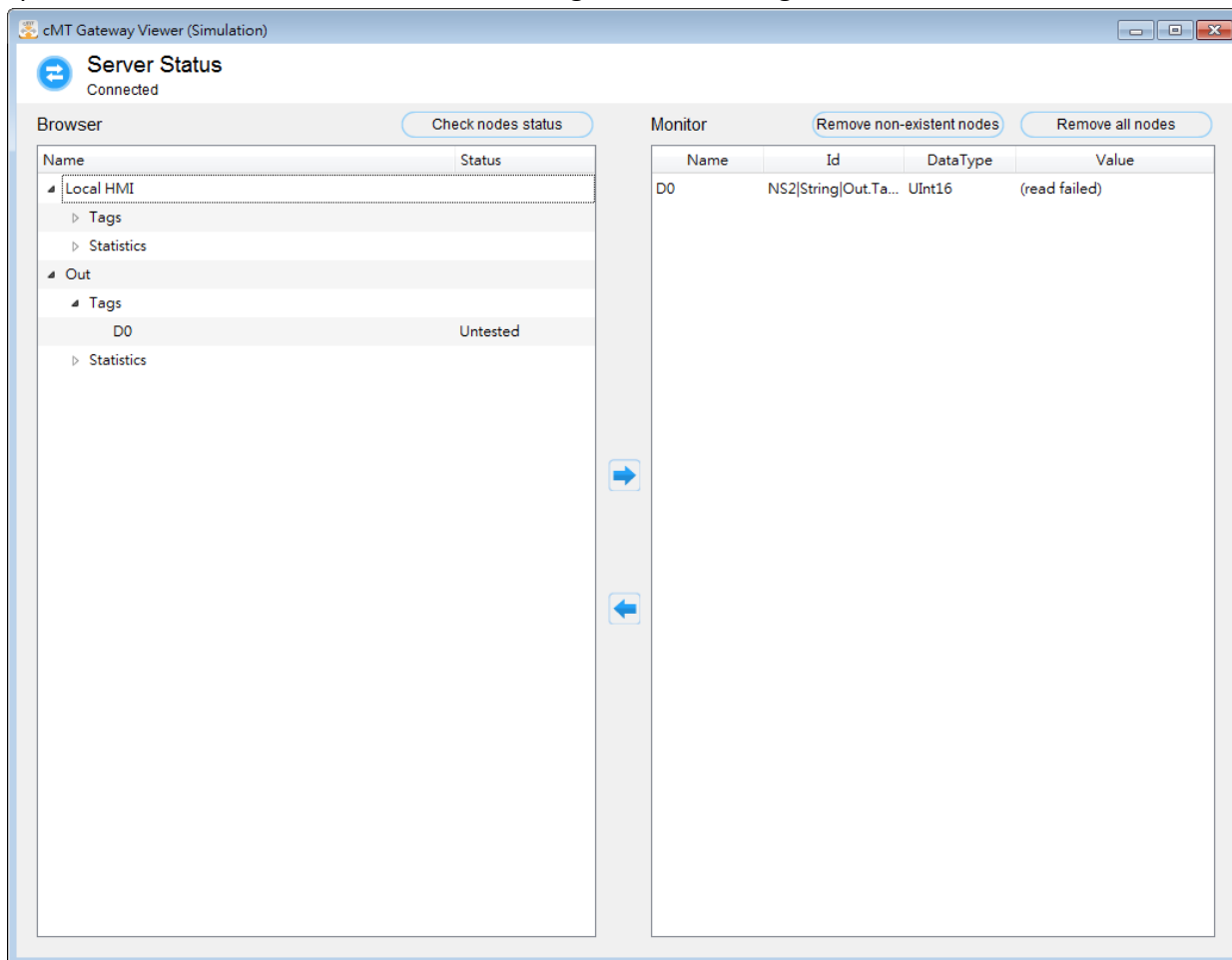

## Chapter5. Functions supported by cMT-G03

- OPC UA Server  
[UM016009E OPC UA UserManual en.pdf](#)
- EasyAccess 2.0  
[UM016001E EasyAccess2 UserManual eng.pdf](#)
- MQTT
- Database Server
- Administrator Tools
- Time synchronization (NTP)
- Macro
- Project protection
- Pass-through
- Data Transfer (Global) object
- Off-line / On-line Simulation
- Recipes (RW, RW\_A)
- Data Log
- Event Log (please note that cMT-G03 cannot read history data saved in an external device)
- E-Mail
- Scheduler

## Chapter6. OPC UA Web Management Interface

### 6.1. Introduction

cMT-G03 provides a web-based tool for convenient access to OPC UA configurations.

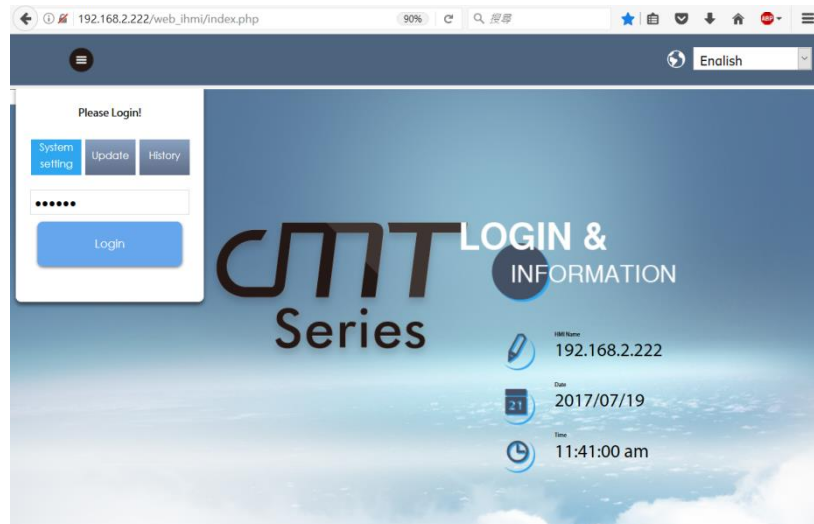

Open cMT-G03's webpage by entering its IP address into the address bar of a web browser. At the entry page, log in with System setting's password. Factory default of the password is 111111. (Suggested resolution: 1024x768 or higher)

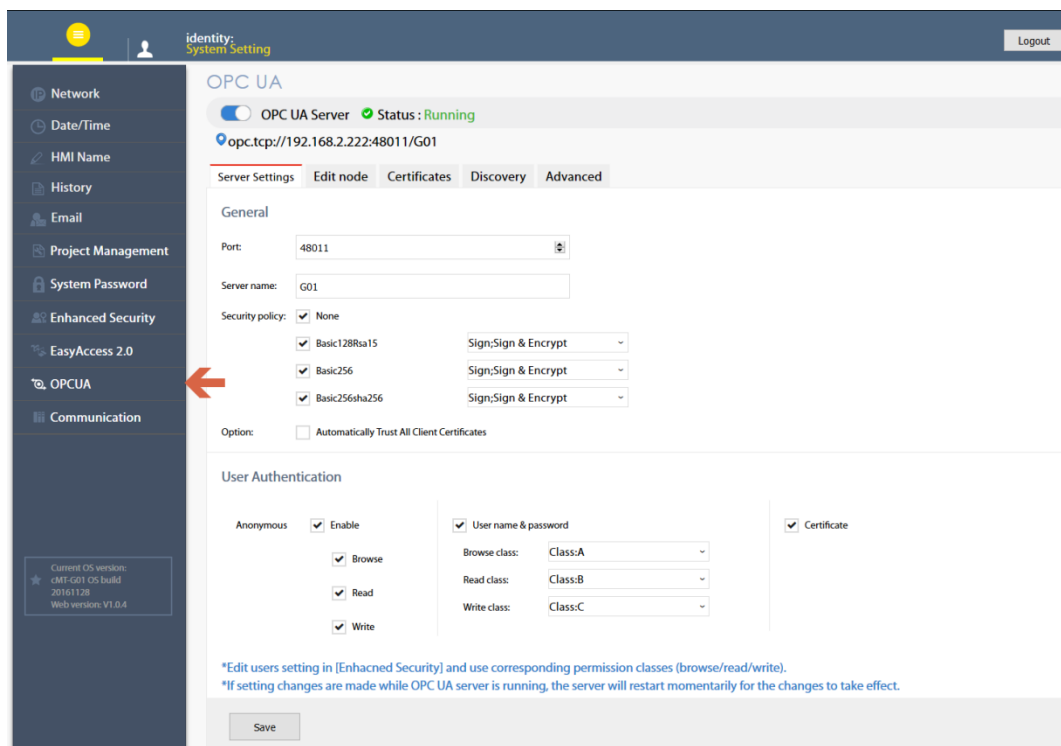

Navigate to the OPC UA configuration page from the context menu on the left.

The OPC UA configuration page consists of a Startup/Shutdown control with status bar and tabbed windows including: Server settings, Edit node, Certificates, Discovery, and Advanced.

Usage of each window tab:

| Tab                    | Description                                                                          |
|------------------------|--------------------------------------------------------------------------------------|
| <b>Server settings</b> | Configure server settings such as port, name, security, user authentication.....etc. |
| <b>Edit node</b>       | Manage tags used by OPC UA server.                                                   |
| <b>Certificates</b>    | Manage certificates used by OPC UA server.                                           |
| <b>Discovery</b>       | Manage list of discovery server.                                                     |
| <b>Advanced</b>        | Advanced options and features.                                                       |

## 6.2. Startup / Shut Down

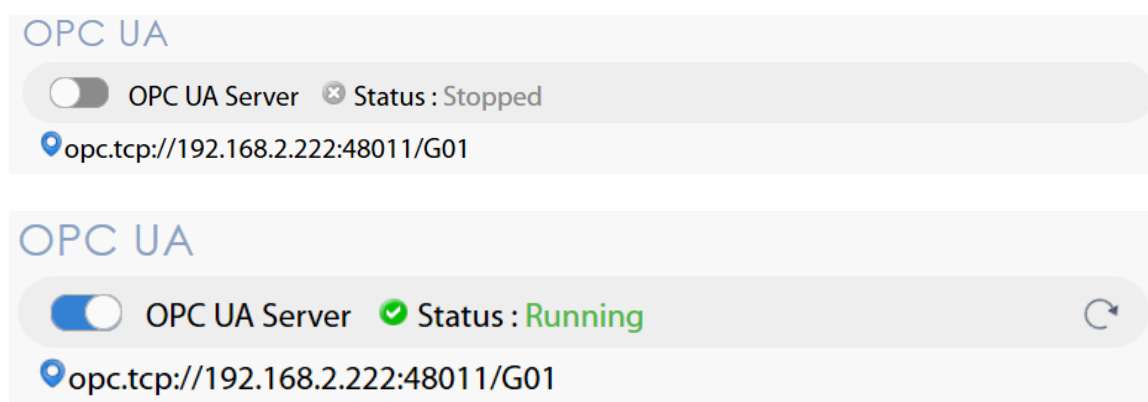

Use the toggle button to start up or shut down the OPC UA server. If there is active client connection, when shutting down, the server will wait for a few seconds before closing off completely.

In addition, both the toggle button and a line of text also indicate the status of the server. The status is refreshed approximately every 10 seconds. An icon on the right  indicates that the status is being refreshed.

Endpoint URL is also displayed for user's reference.

\*Whenever a page refresh is desired, use the menu on the left. Avoid using the browser's refresh button to reload a tab as you may be asked to enter the password to log in again.

## 6.3. Server Settings

The Server settings page shows general configurations of the OPC UA server.



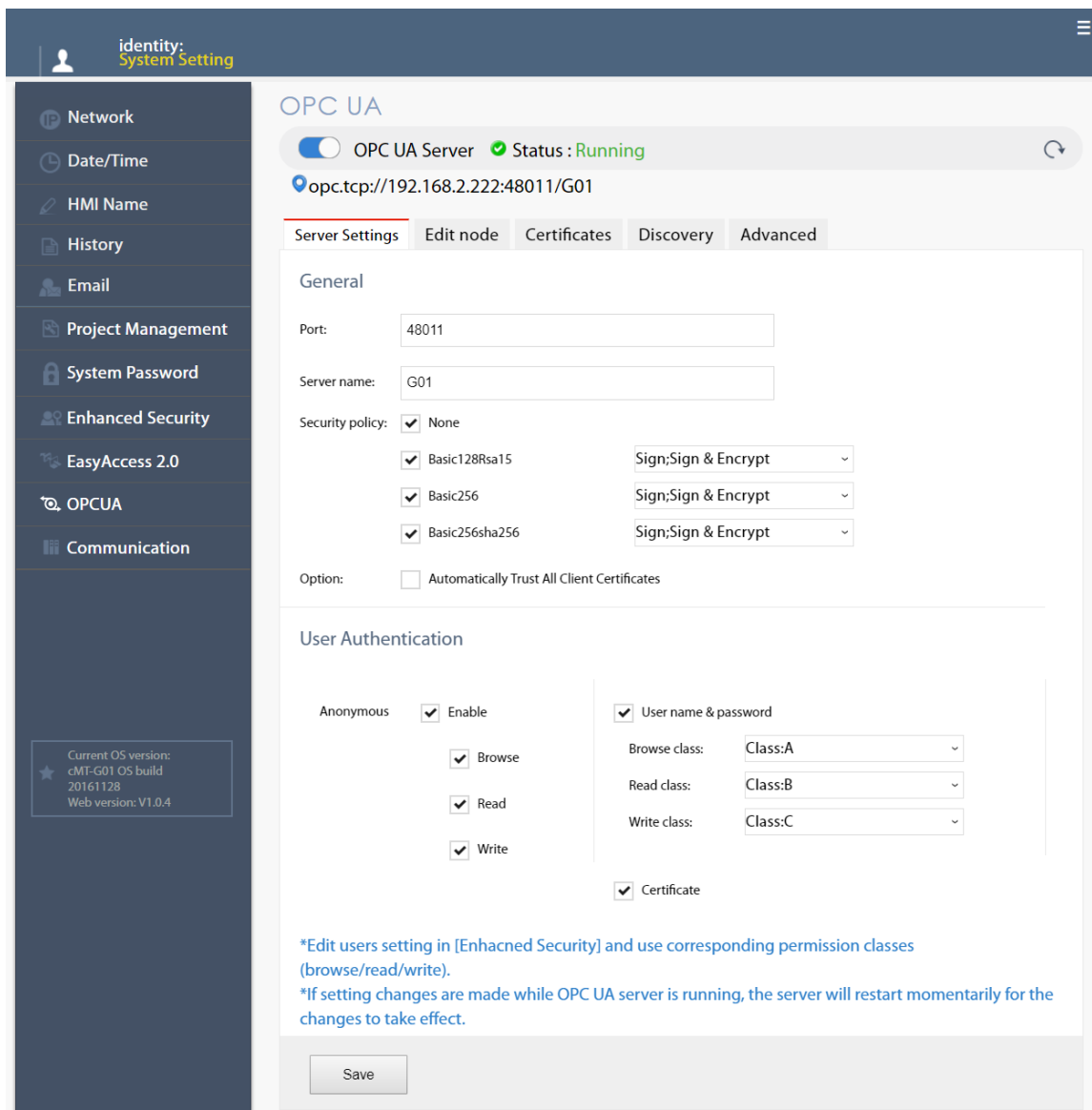

| General                | Function                                                                                                                                                     |
|------------------------|--------------------------------------------------------------------------------------------------------------------------------------------------------------|
| <b>Port</b>            | Access port of the OPC UA server                                                                                                                             |
| <b>Server name</b>     | Server name of the OPC UA server                                                                                                                             |
| <b>Security policy</b> | Supported security policies. At least one must be selected.<br>Supported Policy: None, Basic128Rsa15, Basic256, Basic256sha256<br>Mode: Sign, Sign & Encrypt |
| <b>Option</b>          | Automatically Trust all client certificates: by enabling this option, the OPC UA server will trust the certificate from any client connection.               |

OPC UA server must be configured with at least one user authentication mode as listed in the following table.

| Authentication                  | Descriptions                                                                                                                                                                                                                           |
|---------------------------------|----------------------------------------------------------------------------------------------------------------------------------------------------------------------------------------------------------------------------------------|
| <b>Anonymous</b>                | Allow anonymous client connection. At least one of Browse, Read, or Write modes must be selected.                                                                                                                                      |
| <b>User name &amp; Password</b> | Allow user authentication with username and password. Each access mode, browse, read, and write can be assigned to a user class. User classes are configured in the Enhanced Security mode on the web interface or in EasyBuilder Pro. |
| <b>Certificate</b>              | User authentication with X.509 certificate                                                                                                                                                                                             |

After completing settings, click the Save button to save the changes. OPC UA server will shut down momentarily and then restart for the changes to take effect.

#### 6.4. Edit Node

The screenshot shows the 'OPC UA' configuration page in the 'System Setting' interface. The 'OPC UA Server' is currently 'Running'. The 'Edit node' tab is active, showing a tree view of nodes and tags. The selected tag 'tag 1' is highlighted in blue. The 'Information' panel on the right displays the following details:

| Information     |               |
|-----------------|---------------|
| Tag Name:       | tag 1         |
| Type:           | Bit           |
| PLC:            | MODBUS TCP/IP |
| Address:        | 0x 1          |
| Index register: | N/A           |
| Date type:      | BOOL          |
| Length:         | 1             |
| Access:         | Read   Write  |

A note at the bottom of the page states: '\*After editing the tags, use the Save button below to apply the changes to the OPC UA server. If OPC UA server is running, the server will restart momentarily for the changes to take effect.'

In this page, the user can view and manage the tags currently available in the OPC UA server. New nodes and groups can be added, while existing nodes and groups can be edited or deleted. For ease of navigation, detail information of the currently selected node/group is displayed on the right. After completing settings, it is necessary to click the Save button to save the changes. OPC UA server will shut down momentarily and then restart for the changes to take effect. Changes will be lost if one exits this page without saving.

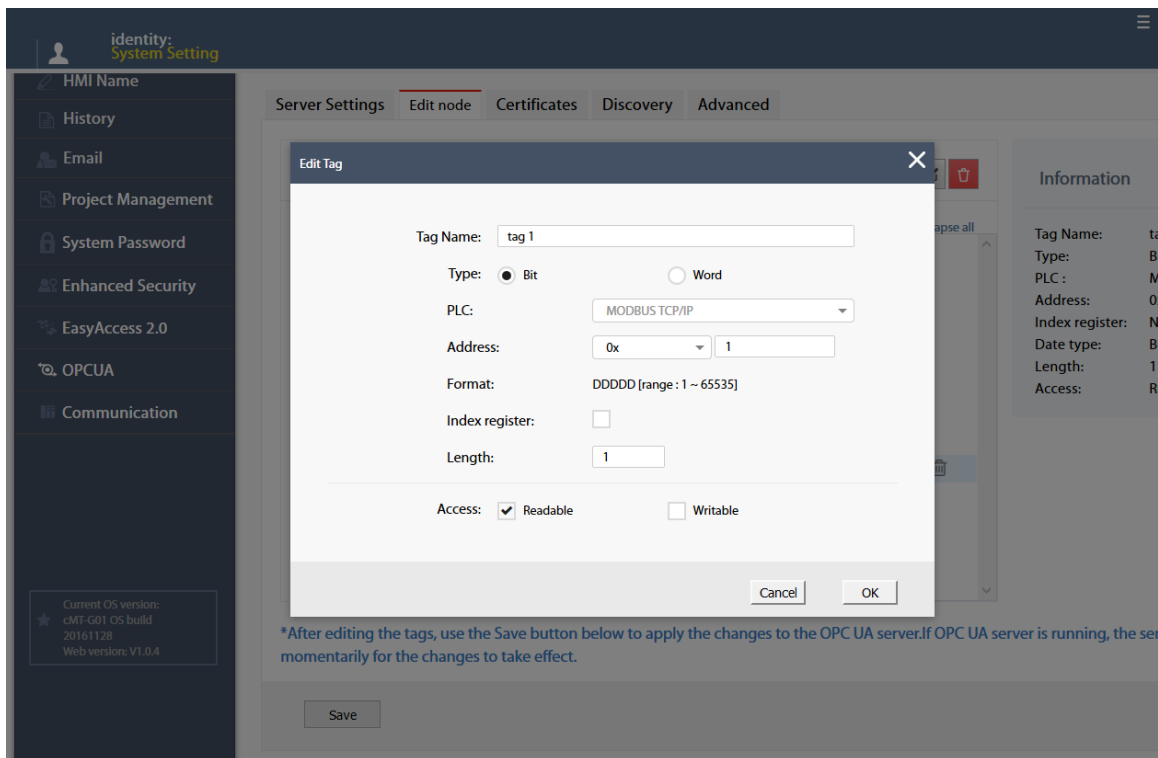

Note that all modifications can only be made for existing drivers. It is not possible to change or add other drivers that are not already available. It is also not possible to edit the nodes of tag PLCs\*.

\*Tag PLCs are characterized by their use of name tags as device memory address as opposed to using device name with indices. Examples of tag PLCs include: BACnet, Rockwell Free Tag Names , Siemens S7-1200/1500 Symbolic Addressing,...etc.

## 6.5. Certificates

In this page, the user can manage certificates and revocation lists of the OPC UA server. Use the dropdown menu to access each page.

If “Automatically Trust All Client Certificates” (in the Server settings tab ) option is not enabled, OPC UA server will reject all client connections and place their certificates in the untrusted list. User may manually “trust” them in this page. Use the reload button  to repopulate the list of certificates if necessary.

Similarly, currently trusted certificates can be manually rejected on the same page.

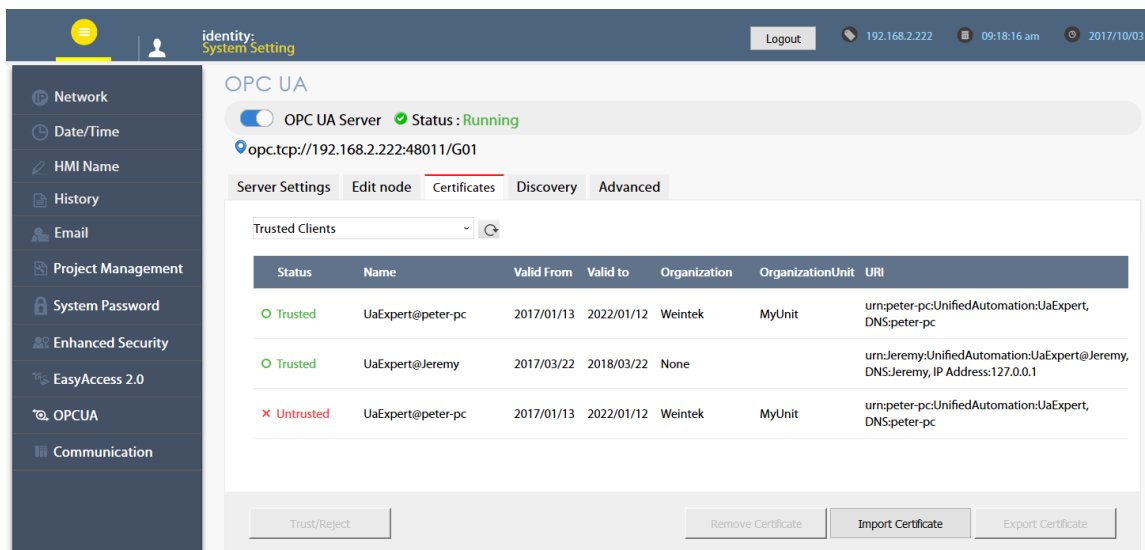

| Page                               | Description                                                                                                                                                                                                                                                                                                                         |
|------------------------------------|-------------------------------------------------------------------------------------------------------------------------------------------------------------------------------------------------------------------------------------------------------------------------------------------------------------------------------------|
| <b>Trusted Clients</b>             | Lists of trusted/rejected client certificates on the server.<br>Supported operation: Trust/Reject, Remove, Import, Export.                                                                                                                                                                                                          |
| <b>Trusted Users</b>               | Lists of trusted/rejected user certificates on the server. Supported operation: Trust/Reject, Remove, Import, Export.                                                                                                                                                                                                               |
| <b>Own</b>                         | Server's own certificate.<br>Supported operation: Update, Remove.<br>When updating own certificate, matching certificate and Private Key must be uploaded together; otherwise, update will fail.<br>A self-signed, 20-year validity certificate will be generated automatically if own certificate is absent when server starts up. |
| <b>Trusted Client Issuers</b>      | List of trusted client issuer certificates.<br>Supported operation: Import, Remove, Export.                                                                                                                                                                                                                                         |
| <b>Trusted User Issues</b>         | List of trusted client issuer certificates.<br>Supported operation: Import, Remove, Export.                                                                                                                                                                                                                                         |
| <b>Certificate Revocation List</b> | Certificate revocation lists for client, user, client issuer, and user issuer.<br>Supported operation: Import, Remove, Export                                                                                                                                                                                                       |

### 6.6. Discovery

OPC UA server can register itself with Local Discovery Servers. In this page, the user can maintain the list of discovery servers that OPC UA server will register with during startup. Should the discovery server be unavailable during server shutdown, the shutdown process will be slightly delayed.

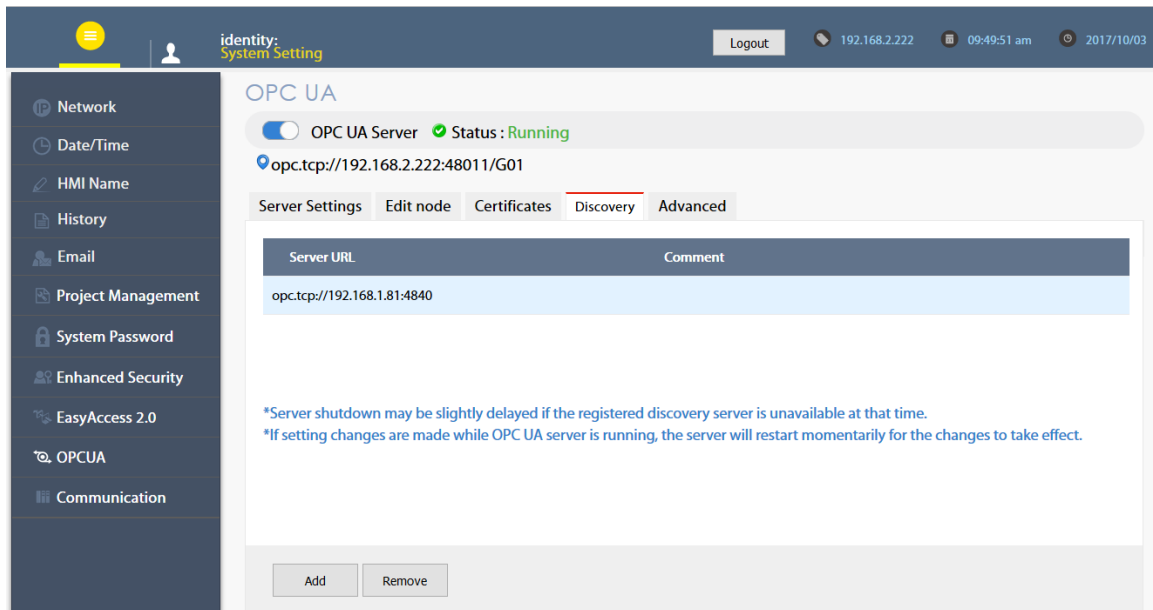

After completing settings, click the Save button to save the changes. OPC UA server will shut down momentarily and then restart for the changes to take effect.

## 6.7. Advanced

Additional settings can be configured in the Advanced tab. The user can set the trace logging level and specific startup behavior of the OPC UA server. Furthermore, the trace log can be downloaded.

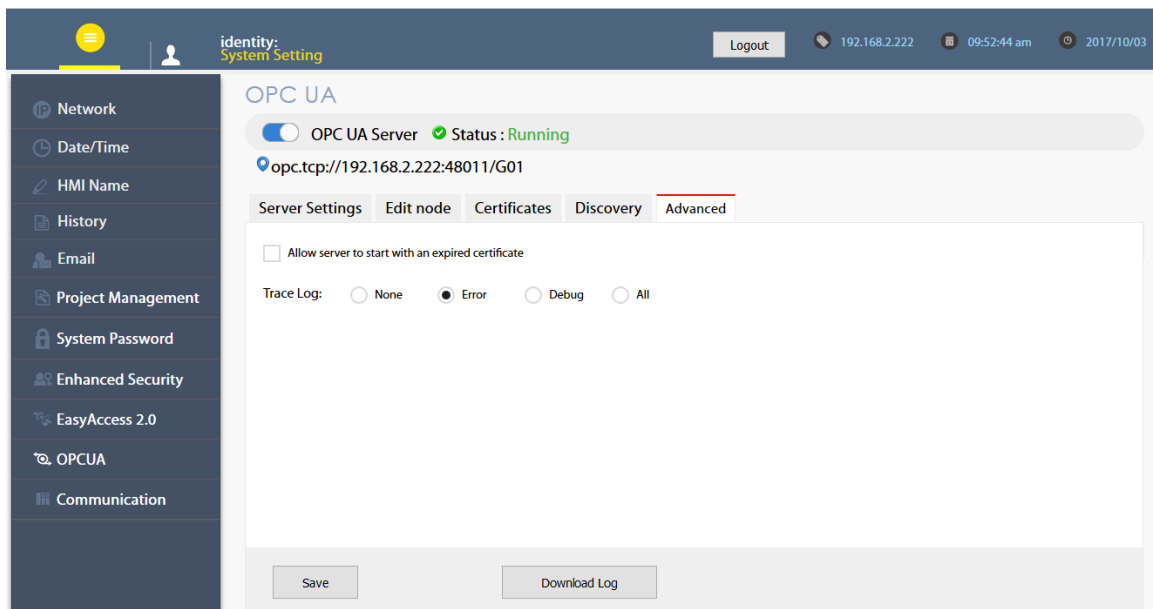

After completing settings, click the Save button to save the changes. OPC UA server will shut down momentarily and then restart for the changes to take effect.

## Chapter7. Tested PLC Drivers

PLC drivers supported by cMT-G03 are shown and can be selected in EasyBuilder Pro.

Table below lists PLC devices tested by Weintek.

| <b>Manufacturer</b> (Alphabetical order) | <b>Driver</b>                                                                                                                                                                                                                           |
|------------------------------------------|-----------------------------------------------------------------------------------------------------------------------------------------------------------------------------------------------------------------------------------------|
| <b>Azbil</b>                             | Azbil MODBUS RTU                                                                                                                                                                                                                        |
| <b>CD Automation</b>                     | CD MODBUS RTU                                                                                                                                                                                                                           |
| <b>Control Technology</b>                | Control Technology 2500 Series                                                                                                                                                                                                          |
| <b>ELSIST</b>                            | ELSIST MODBUS RTU                                                                                                                                                                                                                       |
| <b>FATEK</b>                             | FATEK FB/FBs/B1/B1z Series                                                                                                                                                                                                              |
| <b>KDT SYSTEMS</b>                       | Cimon CM1-SC02A                                                                                                                                                                                                                         |
| <b>KEYENCE</b>                           | KEYENCE KV-10/16/24/40/80/Visual DV Series<br>KEYENCE KV-L20V/700/1000/3000/5000/7500/Nano Series<br>KEYENCE KV-L20V/700/1000/3000/5000/Nano Series (KV Studio Mode)<br>KEYENCE KV-3000                                                 |
| <b>KOYO</b>                              | KOYO CLICK<br>KOYO DIRECT<br>KOYO Do-more<br>KOYO NK1                                                                                                                                                                                   |
| <b>LS</b>                                | LS MASTER-K Cnet<br>LS GLOFA Cnet<br>LS MASTER-K CPU Direct<br>LS GLOFA GM3467 (LOADER)<br>LS MASTER-K MODBUS RTU<br>LS XBM/XBC/XGK CPU DIRECT<br>LS XGK Cnet<br>LS XBM/XBC Cnet<br>LS XEC/XGI CPU DIRECT<br>LS XGI Cnet<br>LS XEC Cnet |
| <b>LS Mecapion</b>                       | LS Mecapion Metronix Anypack                                                                                                                                                                                                            |
| <b>Mitsubishi</b>                        | Mitsubishi FX2N<br>Mitsubishi FX3U/FX3G<br>Mitsubishi AJ71<br>Mitsubishi FX232/485BD<br>Mitsubishi AJ71 (AnA/AnU CPU)<br>Mitsubishi Q00J                                                                                                |

|                          |                                                                                                                                                                                                                                                                                                           |
|--------------------------|-----------------------------------------------------------------------------------------------------------------------------------------------------------------------------------------------------------------------------------------------------------------------------------------------------------|
|                          | <p>Mitsubishi AJ71 (Format 4)</p> <p>Mitsubishi Q06H</p> <p>Mitsubishi Q02/02H</p> <p>Mitsubishi Q00/Q00UJ/Q01/QJ71</p> <p>Mitsubishi Q00U/Q01U/Q02U/QnUD/QnUDH</p> <p>Mitsubishi FX5U</p> <p>Mitsubishi Alpha2</p> <p>Mitsubishi L6ADP</p> <p>Mitsubishi FX2N-10GM/20GM</p> <p>Mitsubishi MR J3/J4 A</p> |
| <b>MODBUS</b>            | <p>MODBUS RTU, RTU over TCP</p> <p>MODBUS ASCII</p> <p>MODBUS RTU (Zero-based Addressing)</p> <p>MODBUS RTU (Adjustable)</p> <p>MODBUS RTU (HEX Addressing)</p>                                                                                                                                           |
| <b>OMRON</b>             | <p>OMRON C/CQM1 Series</p> <p>OMRON CJ/CS/CP</p> <p>OMRON Host Link</p> <p>OMRON E5CN/E5EZ/E5ZN</p>                                                                                                                                                                                                       |
| <b>Panasonic</b>         | <p>Panasonic FP/KW</p> <p>Panasonic MEWTOCOL7</p> <p>Panasonic MINAS-BL KV Series</p>                                                                                                                                                                                                                     |
| <b>Rockwell</b>          | <p>Rockwell DF1</p> <p>Rockwell PLC5</p> <p>Rockwell CompactLogix/FlexLogix</p>                                                                                                                                                                                                                           |
| <b>Schleicher</b>        | <p>Schleicher XCS 20C</p> <p>Schleicher XCX 300</p>                                                                                                                                                                                                                                                       |
| <b>Schneider</b>         | <p>IMS MOTION</p> <p>Schneider Zelio</p> <p>Schneider PowerLogix Modbus RTU</p> <p>Schneider IMS SERVO</p> <p>Schneider MODBUS RTU</p>                                                                                                                                                                    |
| <b>Shenzhen Inovance</b> | <p>Inovance H2U/H1U</p> <p>Inovance H3U Series</p>                                                                                                                                                                                                                                                        |
| <b>Siemens</b>           | <p>Siemens TI505</p> <p>Siemens TI565</p>                                                                                                                                                                                                                                                                 |
| <b>SIKO</b>              | SIKONETZ5                                                                                                                                                                                                                                                                                                 |
| <b>Toshiba</b>           | TOSHIBA T Series                                                                                                                                                                                                                                                                                          |

|                        |                                                                  |
|------------------------|------------------------------------------------------------------|
|                        | TOSHIBA INVERTER VF                                              |
| <b>Toshiba Machine</b> | TOSHIBA MACHINE Provisor TC200                                   |
| <b>Trio Motion</b>     | Trio MODBUS RTU, TCP/IP<br>MODBUS RTU, TCP/IP (Mode 7)           |
| <b>XINJE</b>           | XINJE XC Series                                                  |
| <b>YASKAWA</b>         | YASKAWA MP Series – Memobus<br>YASKAWA MP Series – SIO Extension |
| <b>YOKOGAWA</b>        | YOKOGAWA FA-M3                                                   |